

Top level

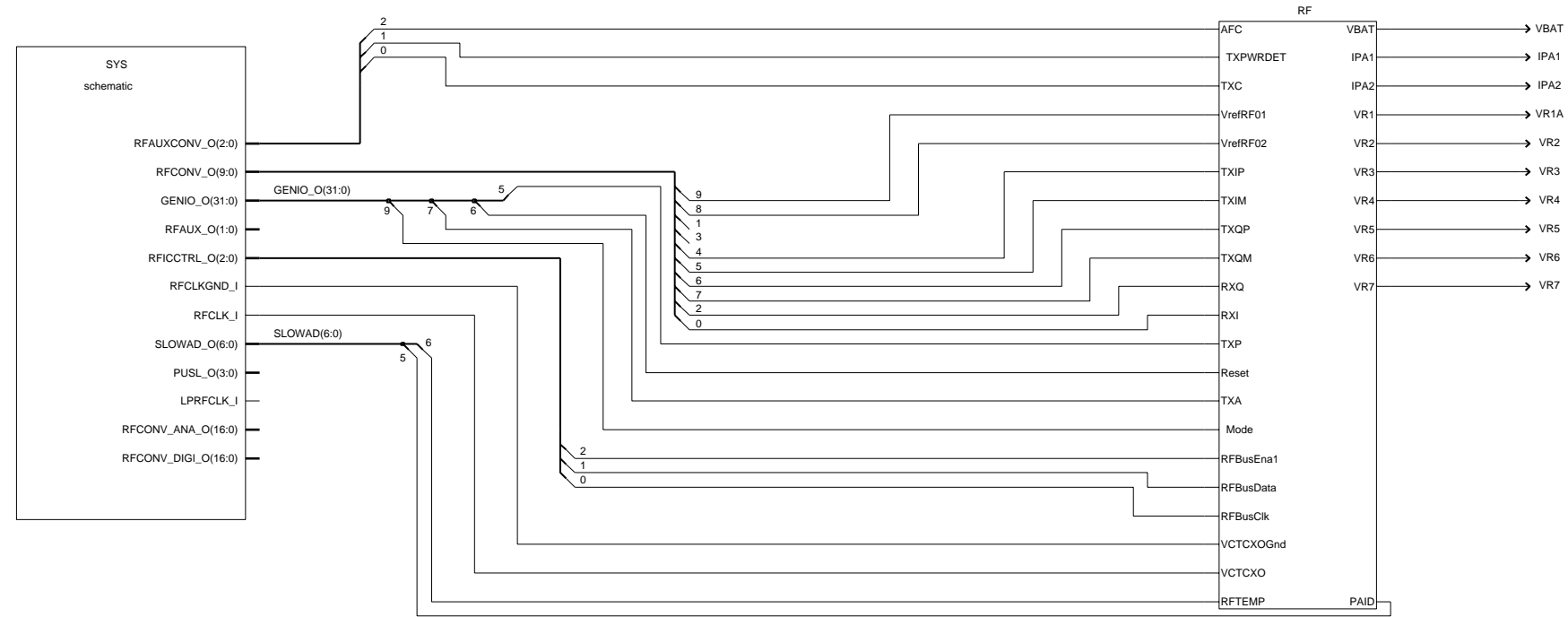

RF Top level

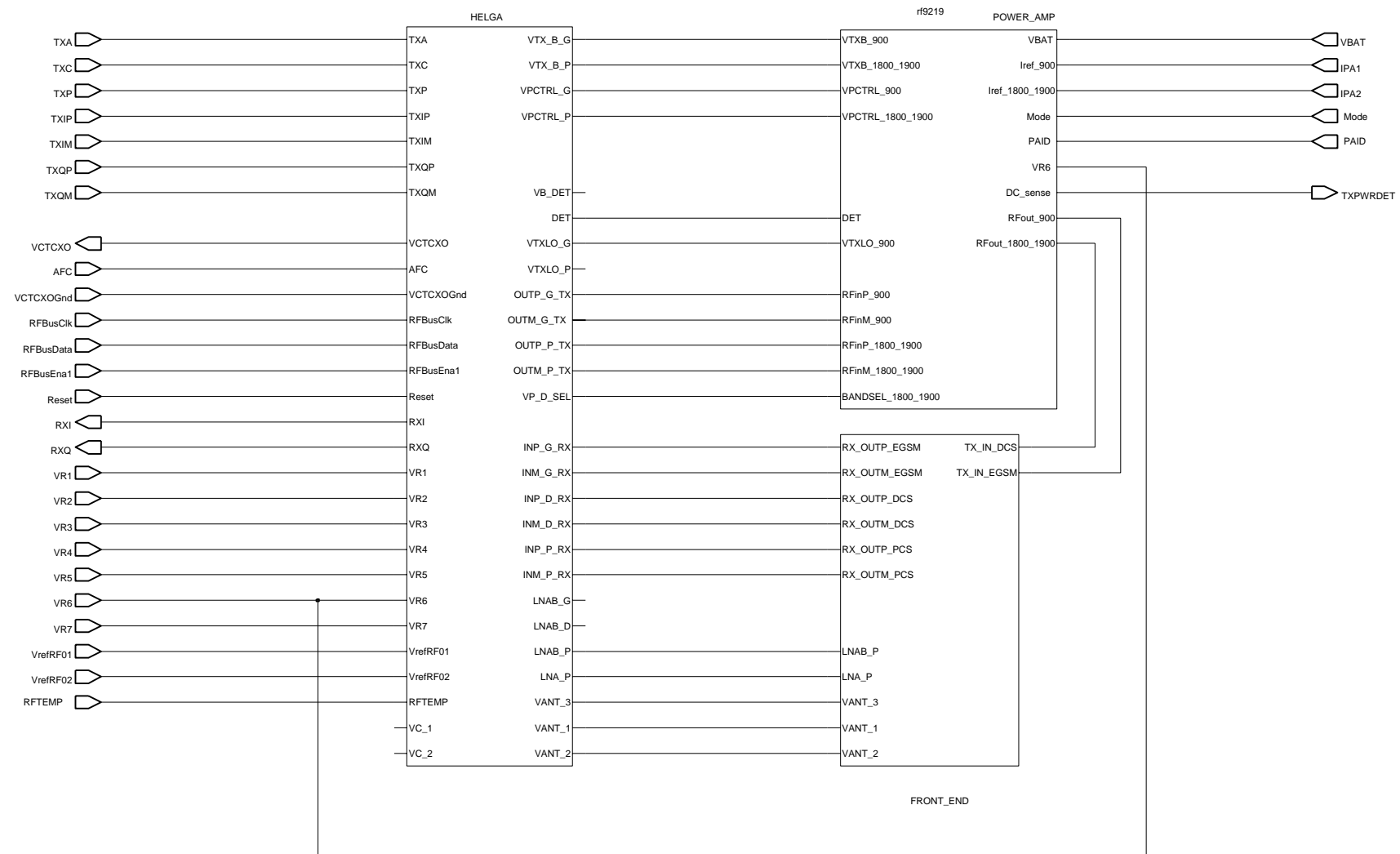

RF shields and vias

BB GLOBAL GND HOLES

RF GLOBAL GND HOLES

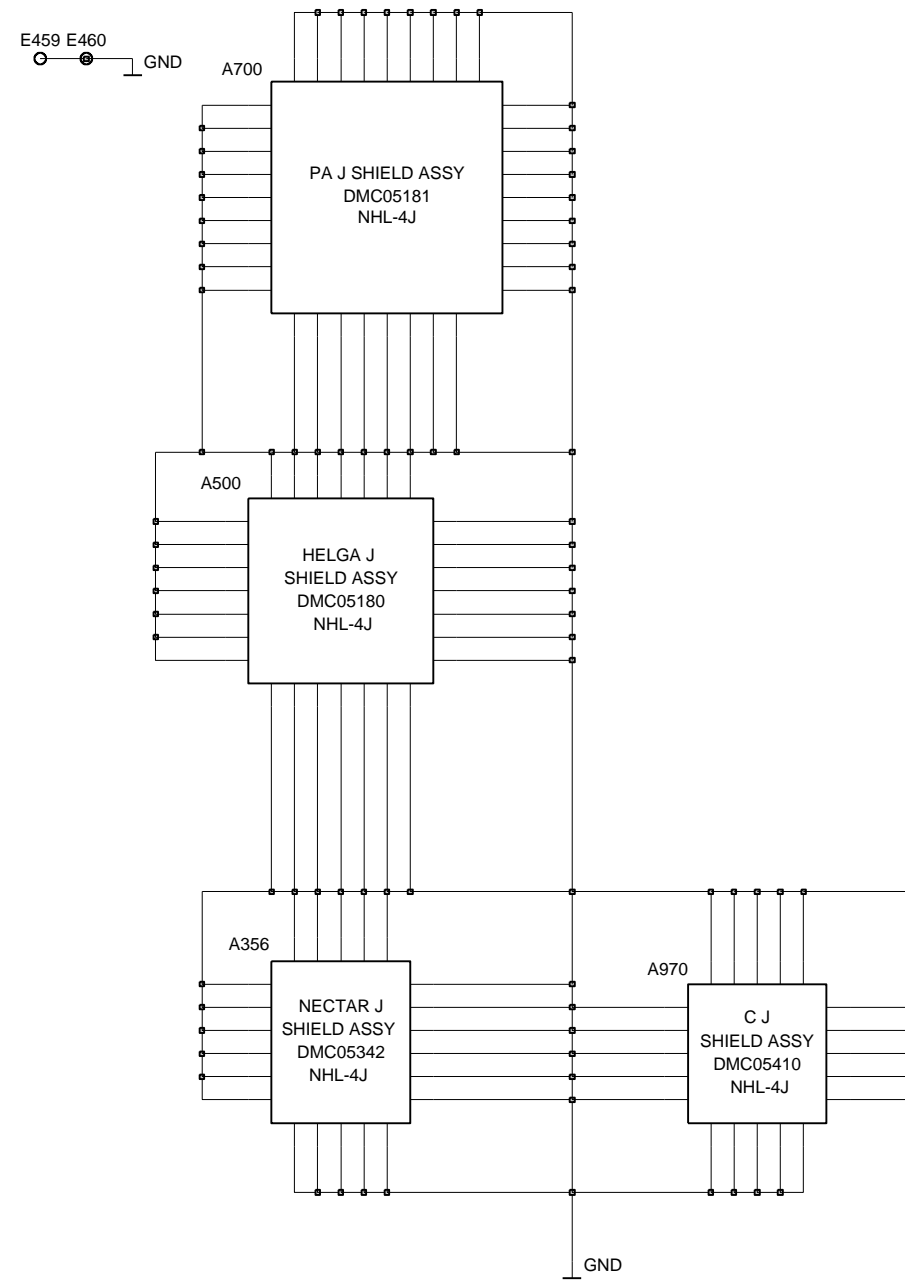

HELGO

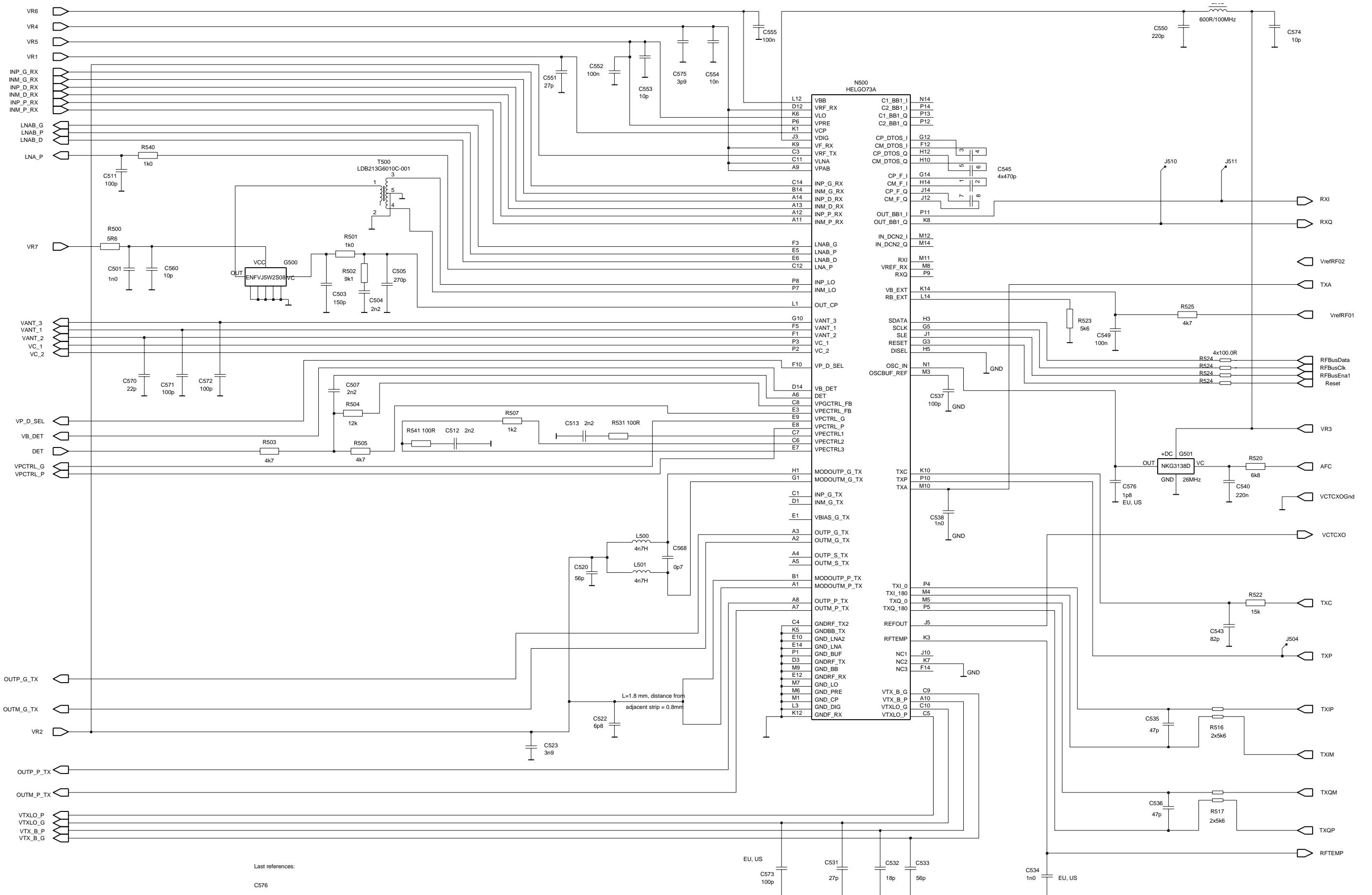

Last references:

C576

R543

L510

T501

Power amplifier and power detection

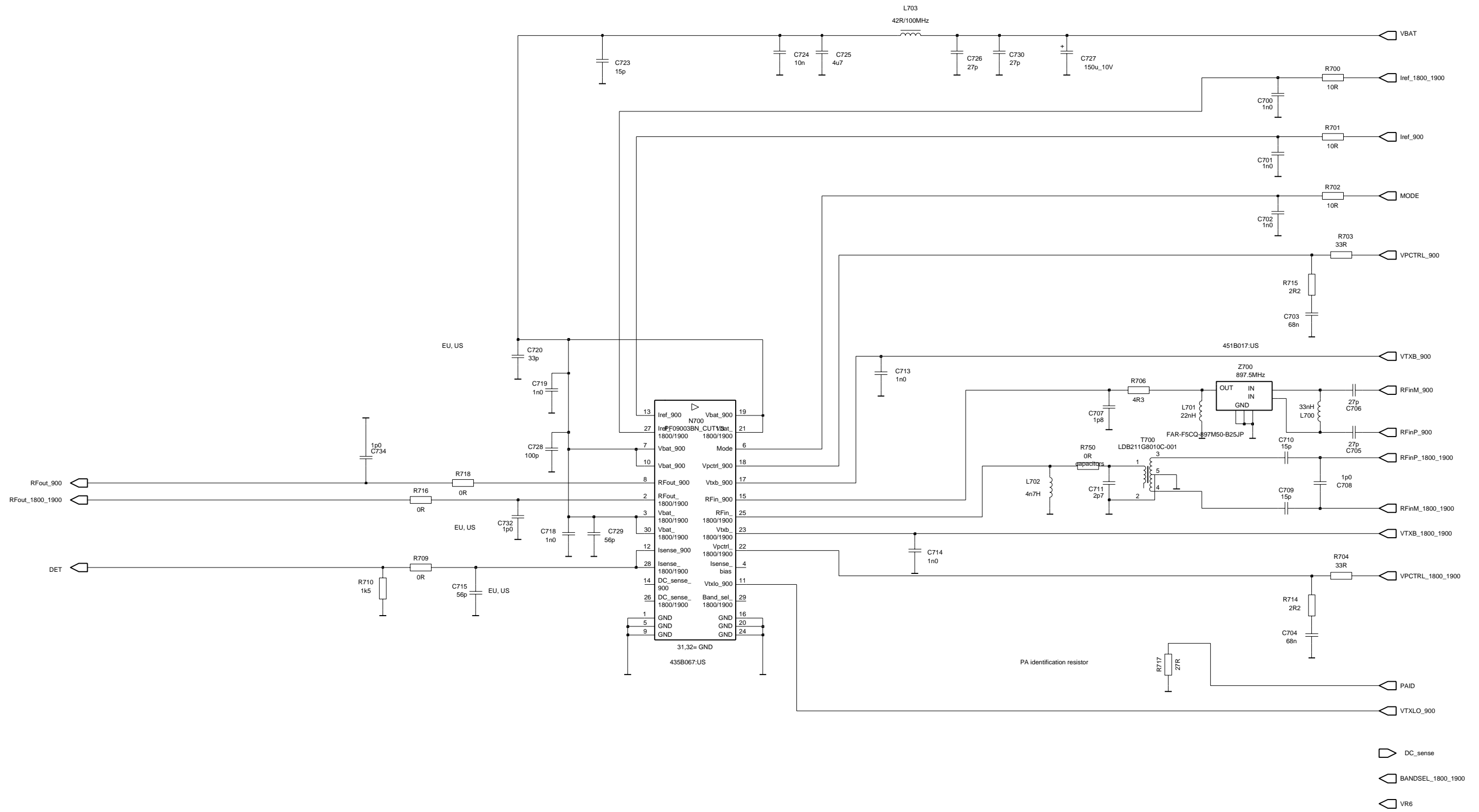

Last references:

C733

R717

L704

RX front end and antenna switch

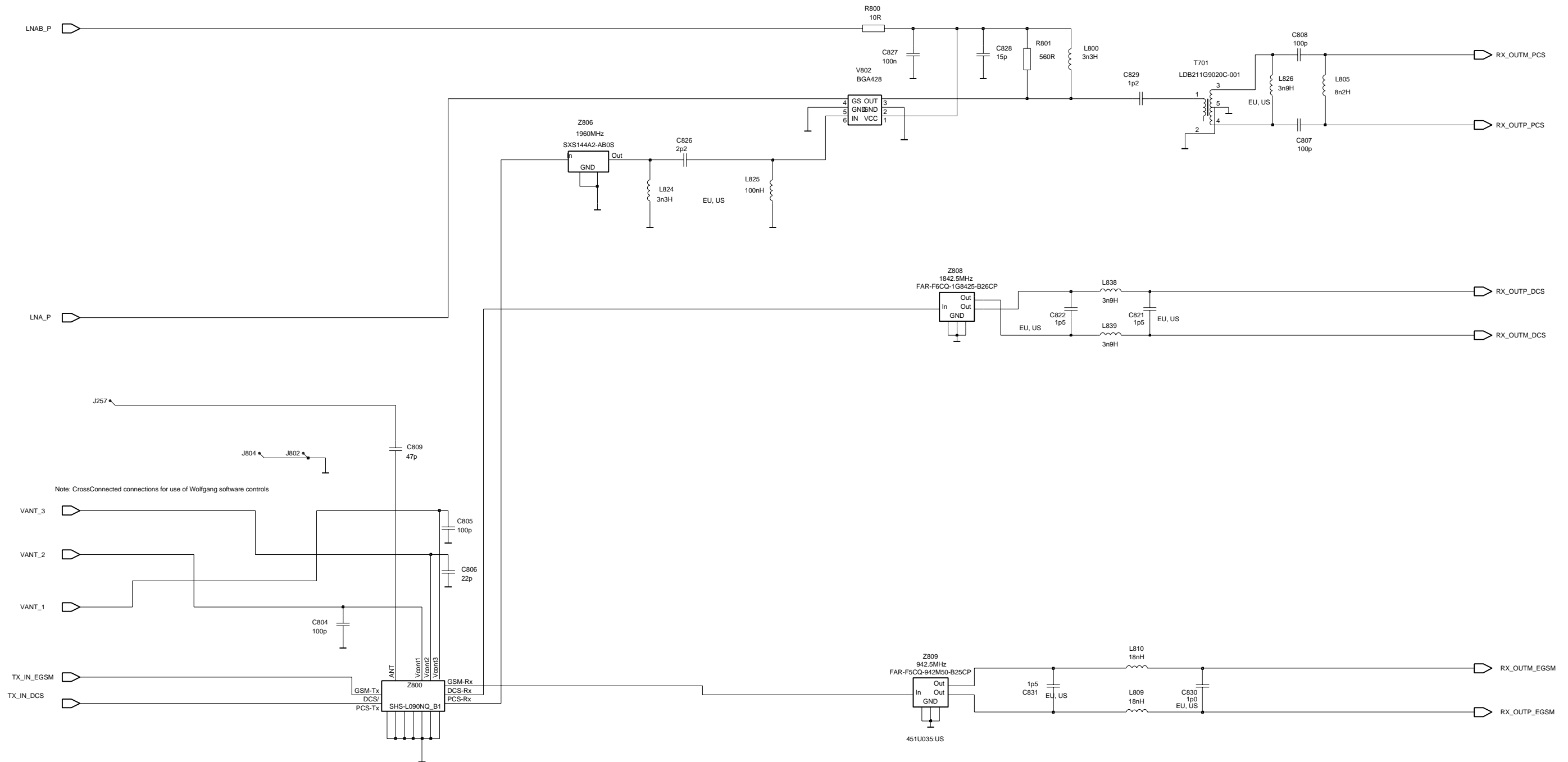

Last references:

C835

R807

L825

Z806

DCT4 Common Baseband (Top)

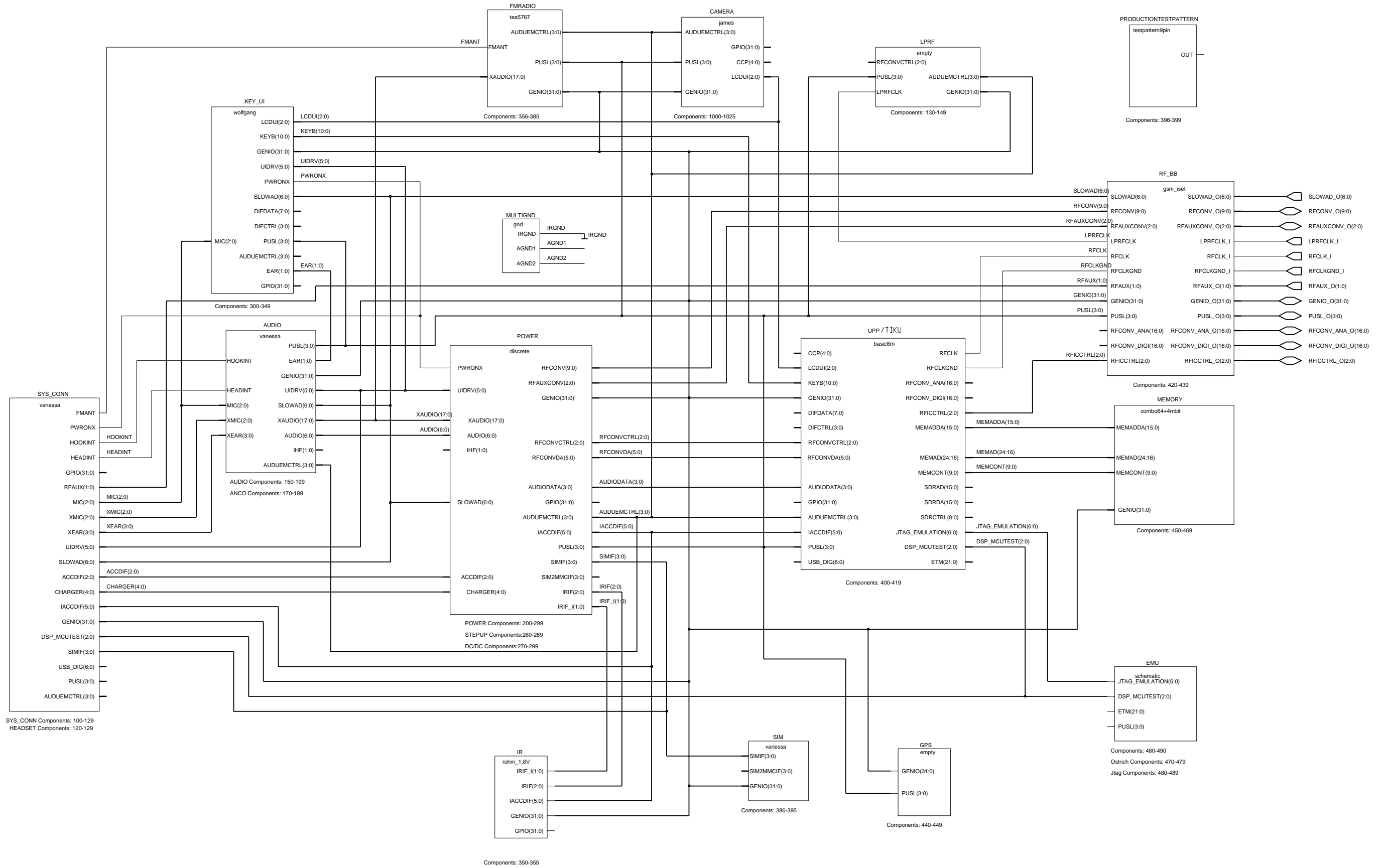

System connector

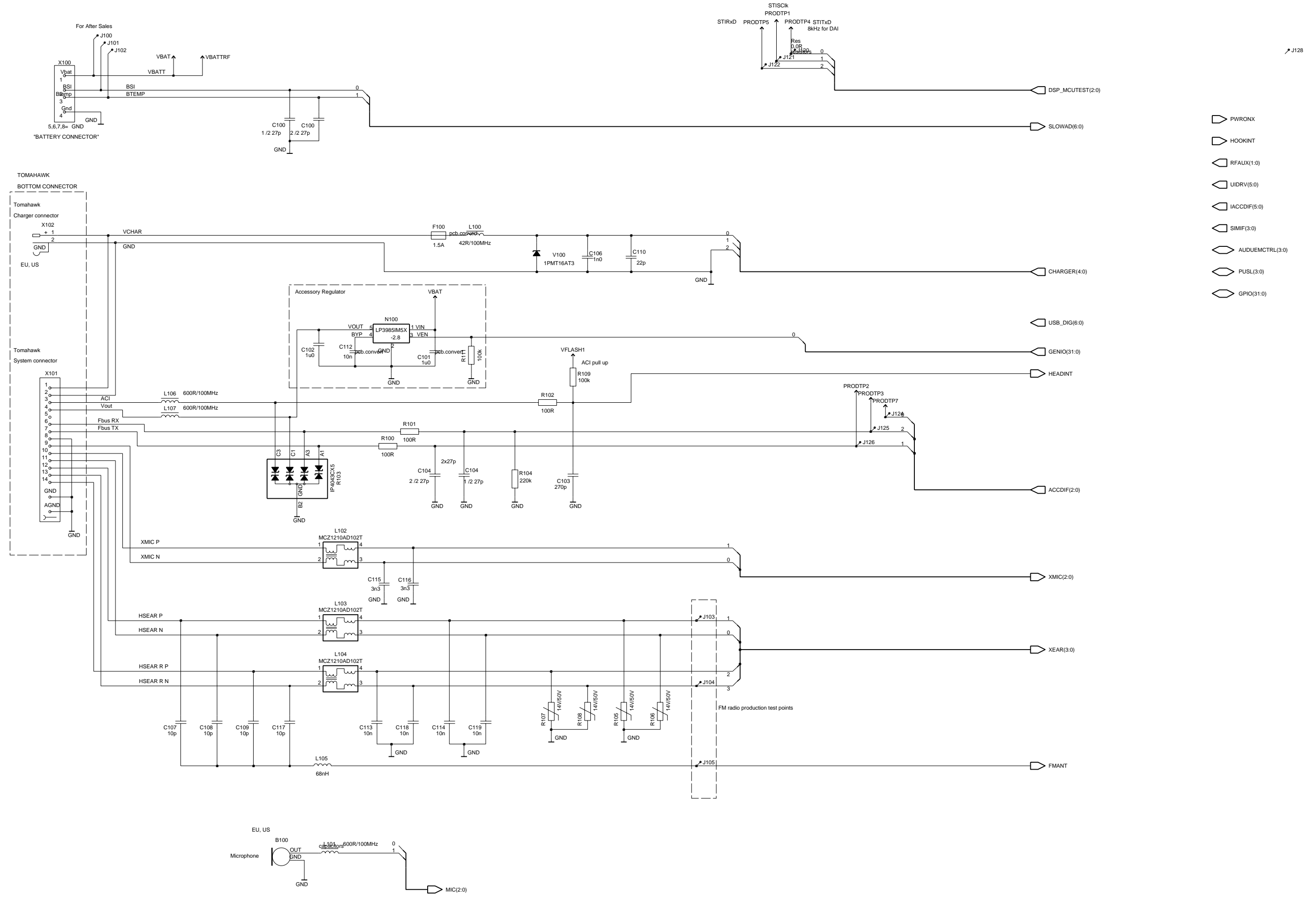

Test and emulator interface

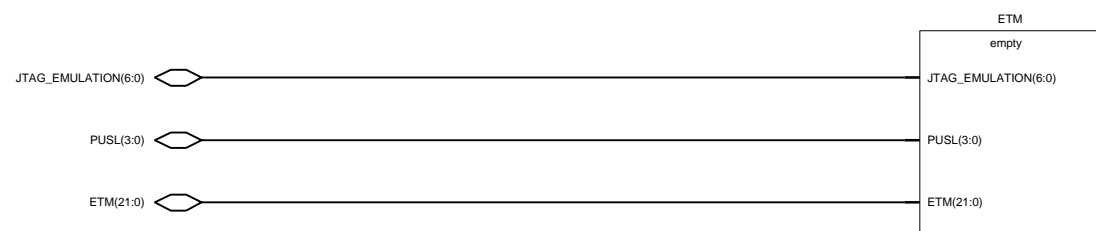

Testpoints for JTAG emulator

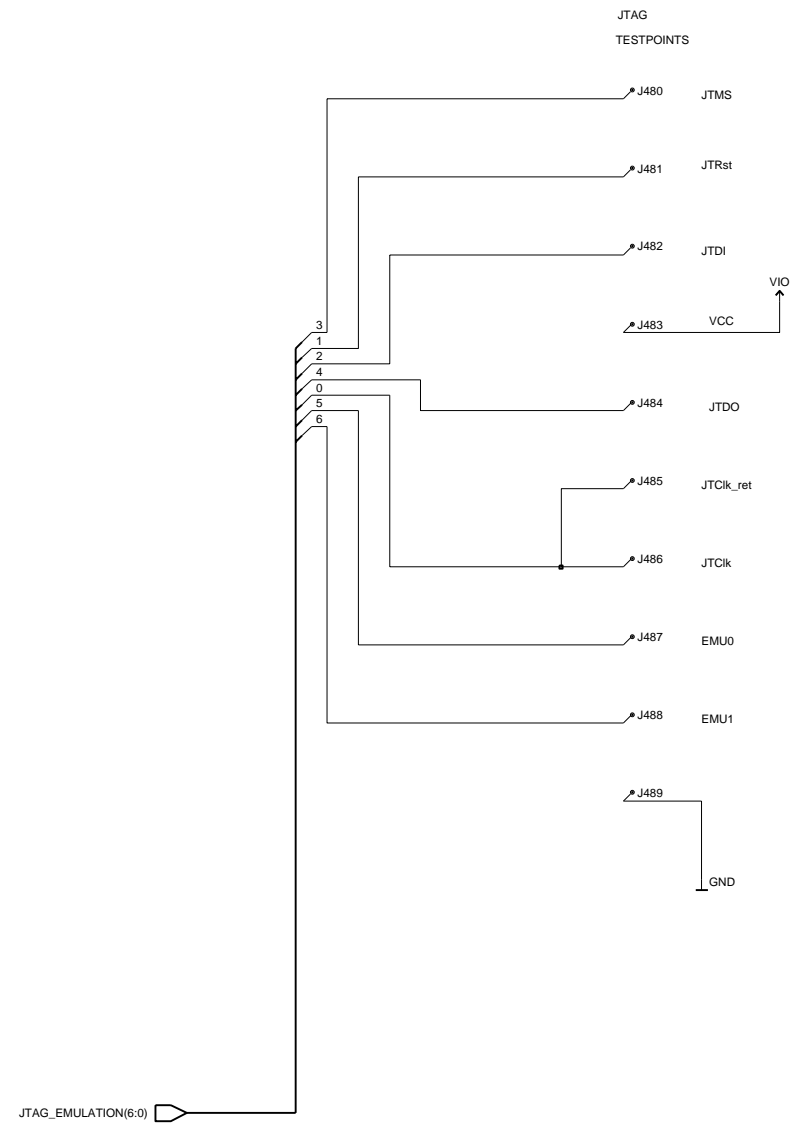

Connector based Ostrich test interface

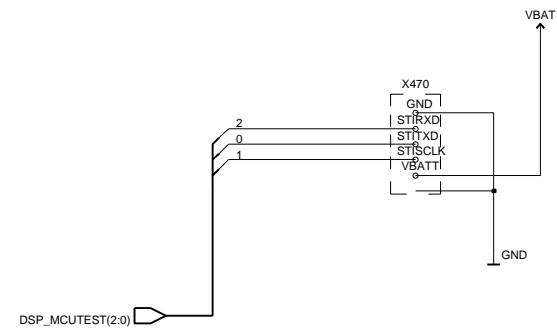

Empty ETM

PUSL(3:0) 

JTAG_EMULATION(6:0) 

ETM(21:0) 

User Interface

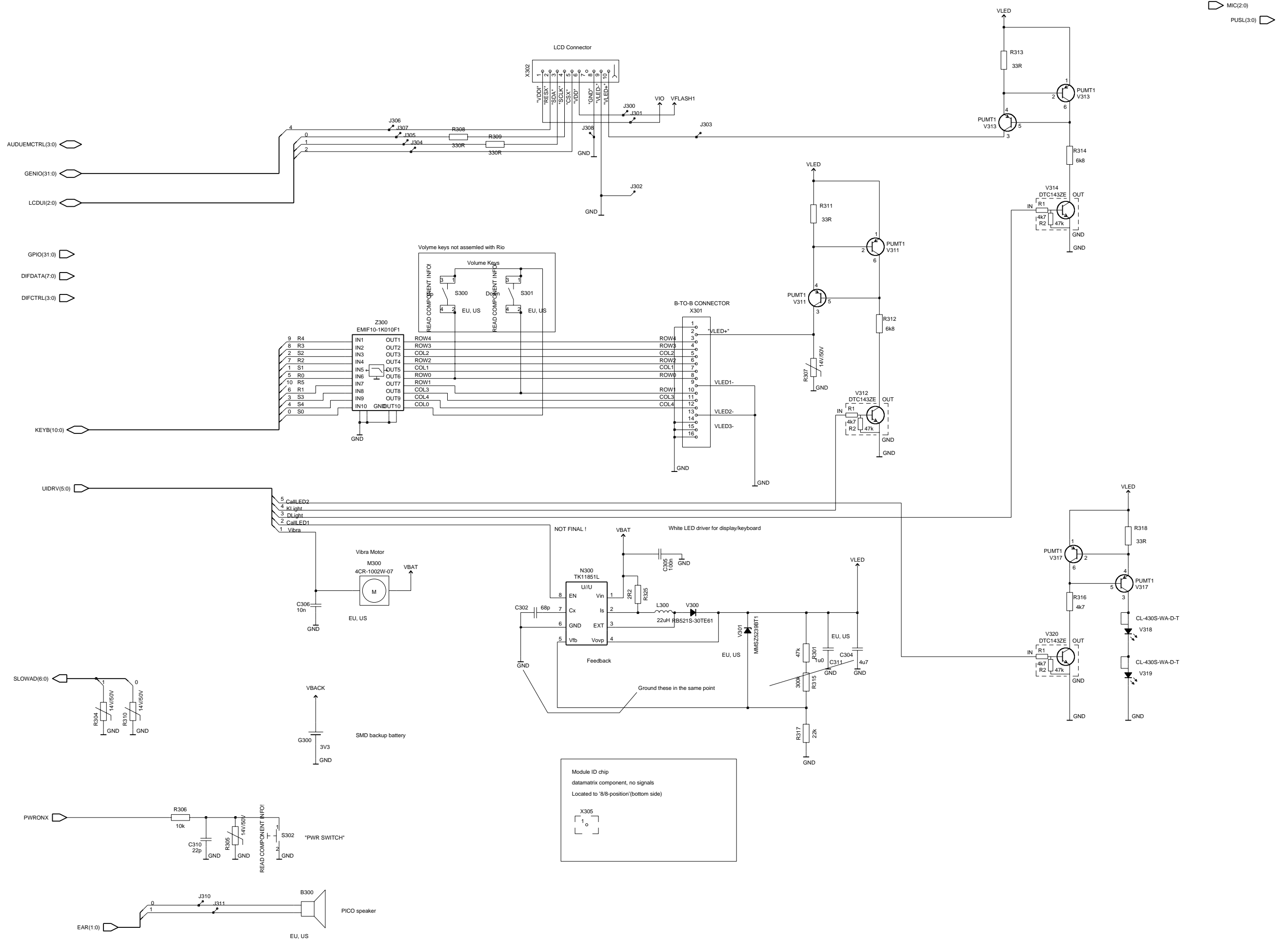

SIM reader

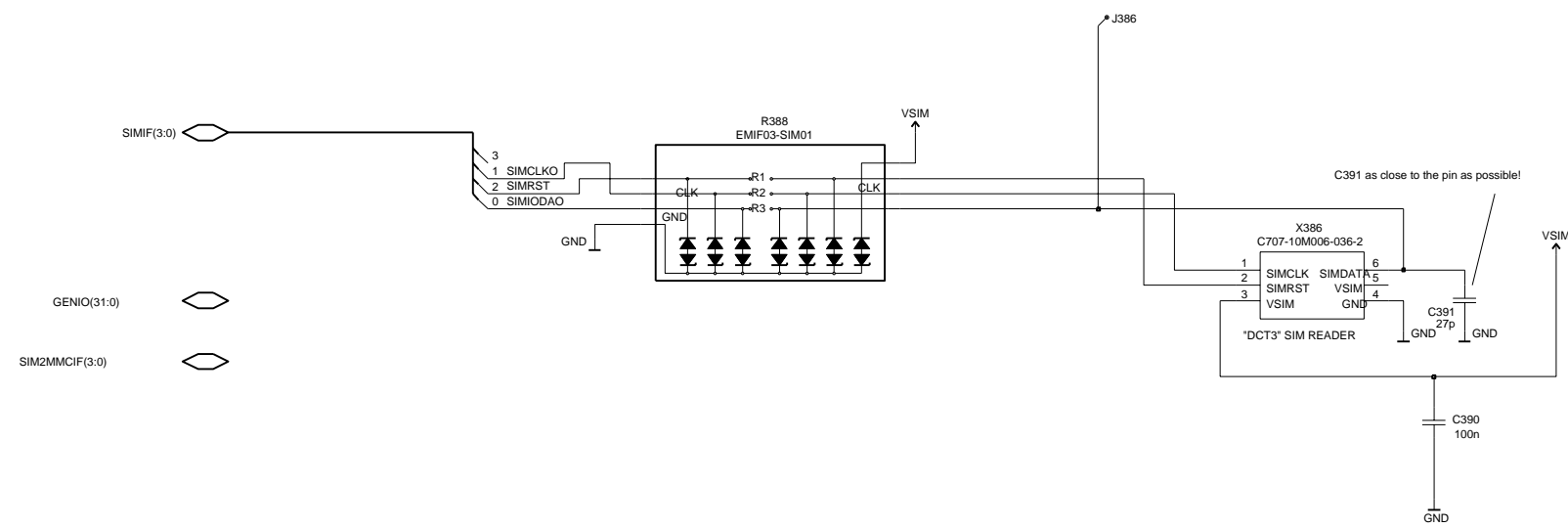

Discrete power management

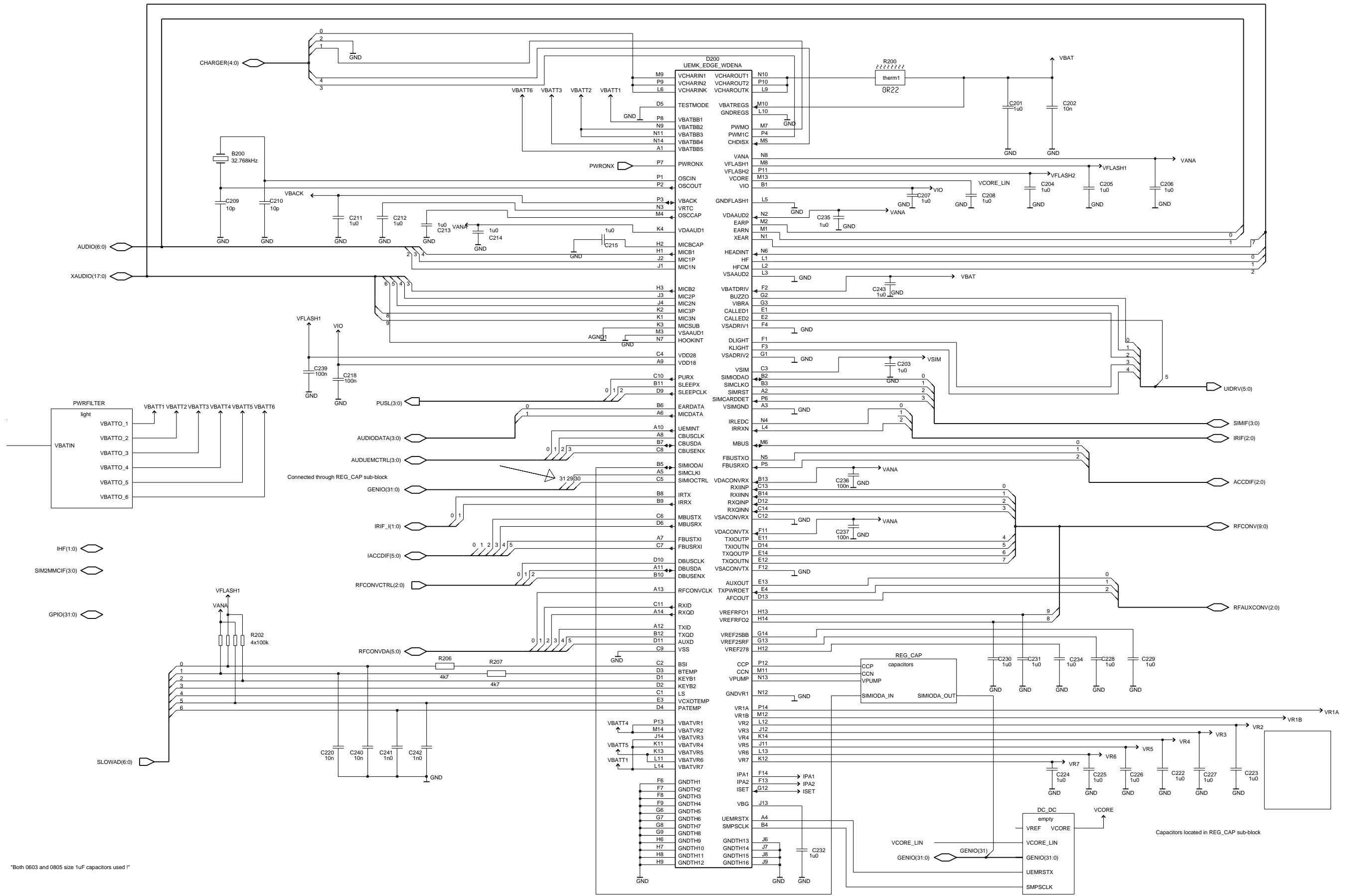

*Both 0603 and 0805 size 1uF capacitors used !

Used refs in REG_CAP: C238, C200, C219, C233, C221 and R205

Capacitors located in REG_CAP sub-block

Light filtering

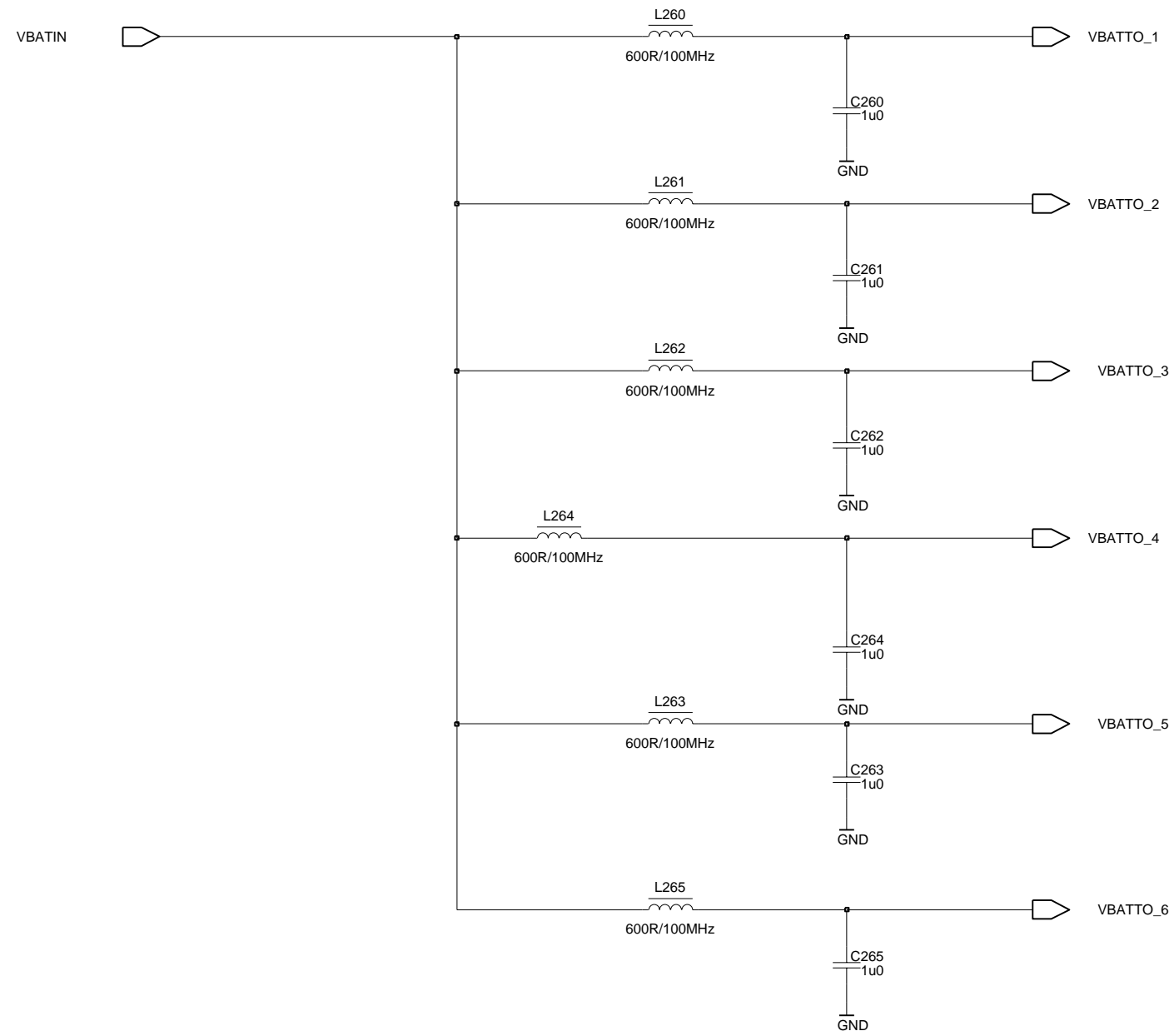

DC/DC converter

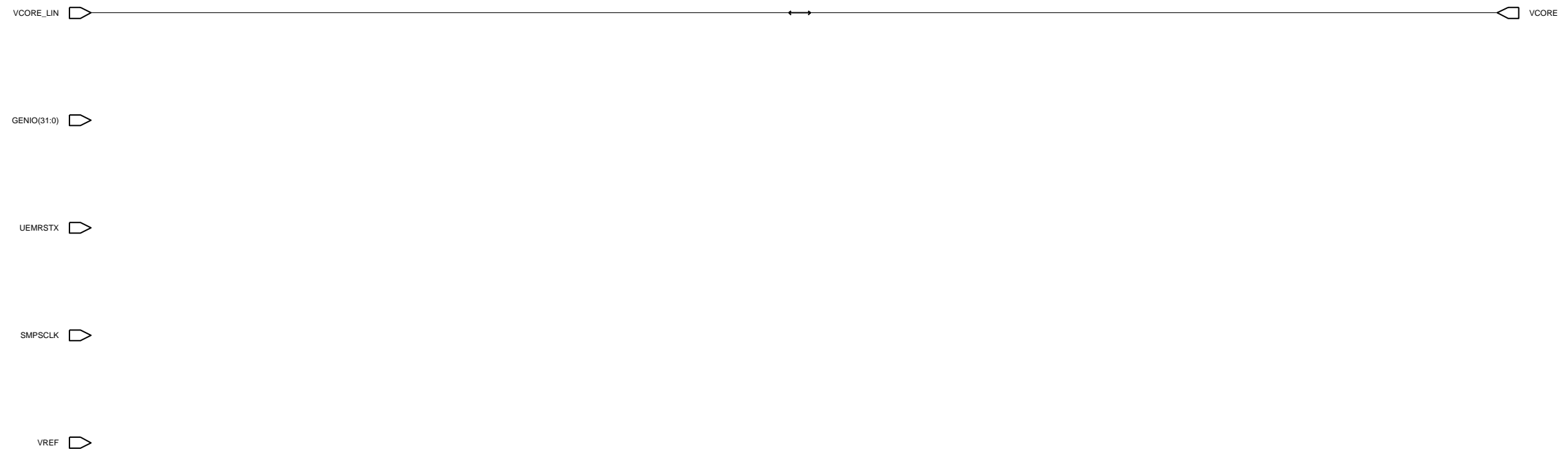

PWR resistor

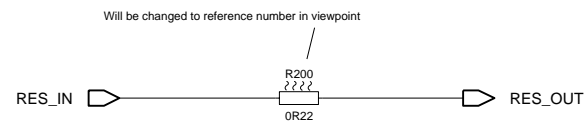

For old discrete power users

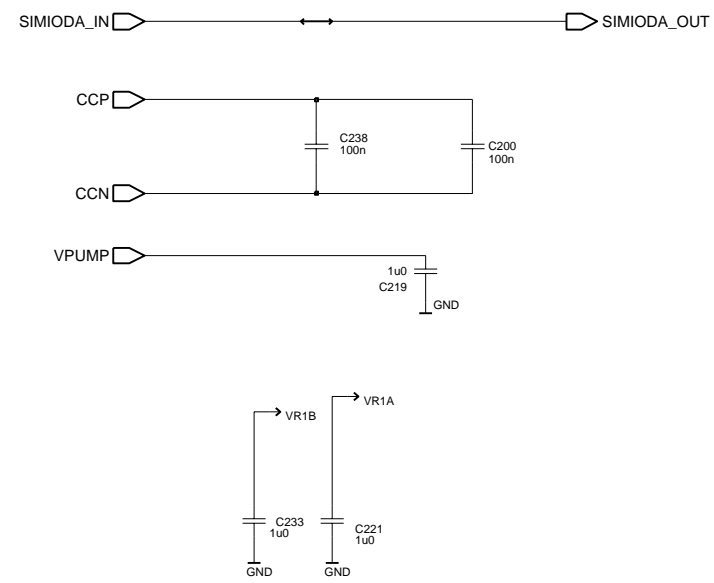

Camera

NOTE! New reference numbers 970-999, usage must be checked from RFI

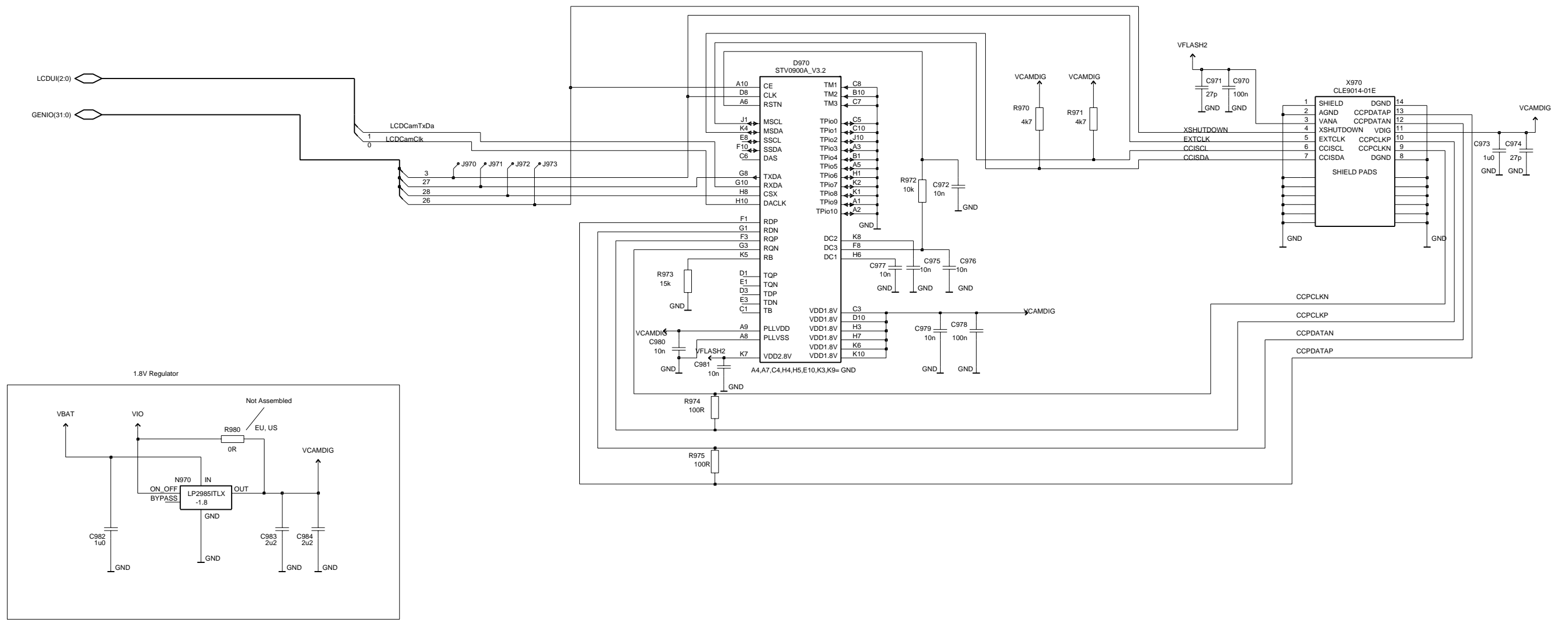
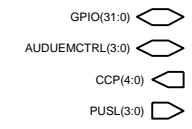

UPP 8M implementation

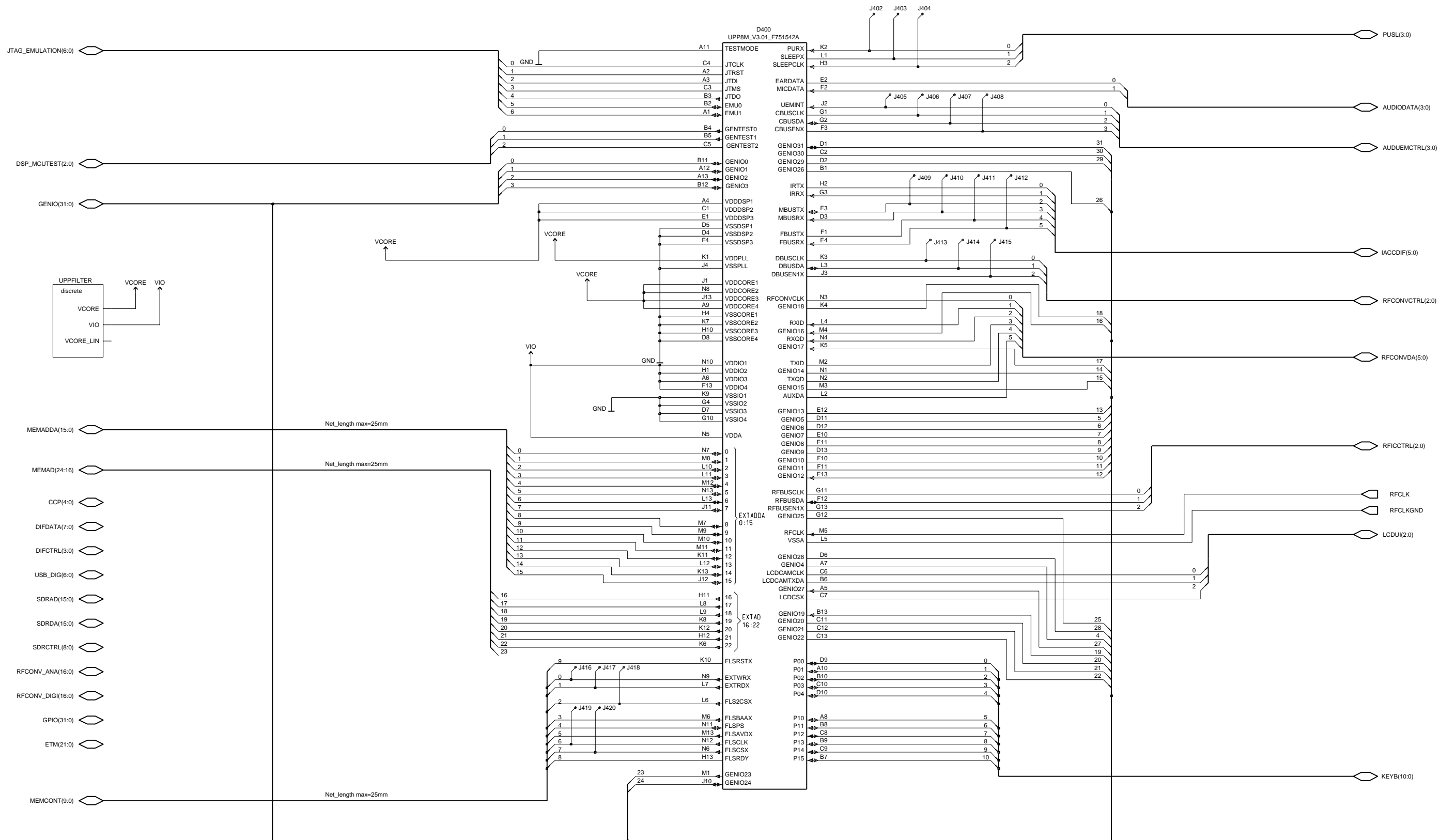

Discrete decoupling capacitors for UPP

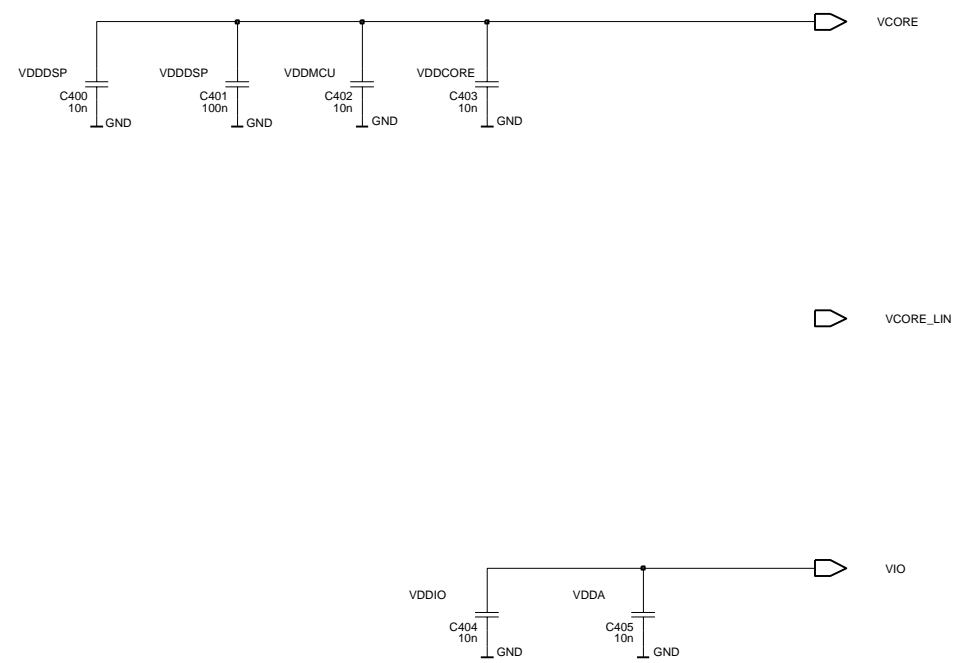

No LPRF interface in this product

GENIO(31:0) 

AUDUEMCTRL(3:0) 

PUSL(3:0) 

RFCONVCTRL(2:0) 

LPRFCLK 

Combo memory 64+4Mbit

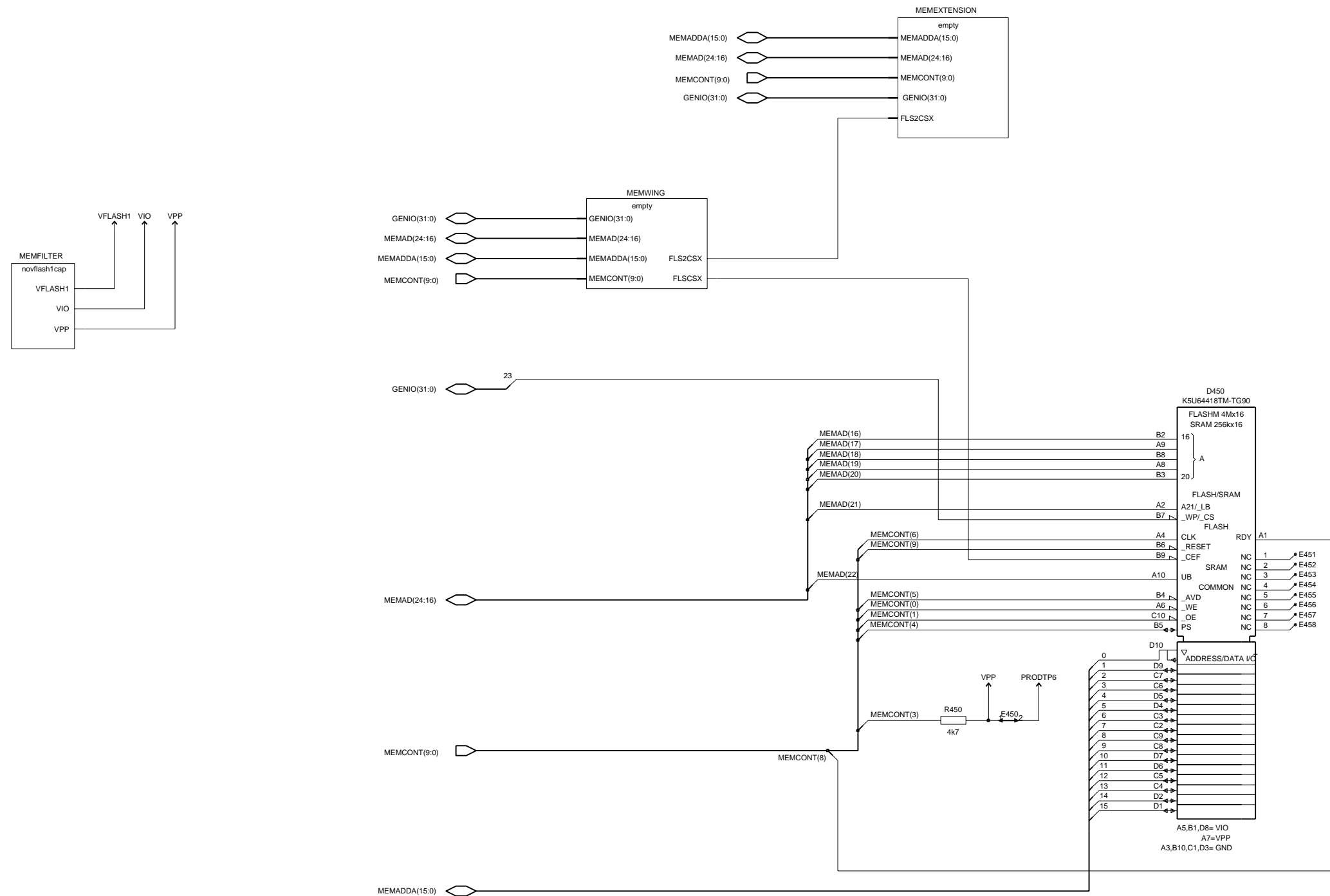

Memory extension

GENIO(31:0) 

FLS2CSX 

MEMAD(24:16) 

MEMCONT(9:0) 

MEMADDA(15:0) 

Empty wing sheet

MEMADDA(15:0) 

MEMAD(24:16) 

GENIO(31:0) 



Discrete capacitors for memory without VFlash1



FM radio unit

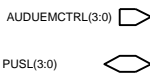
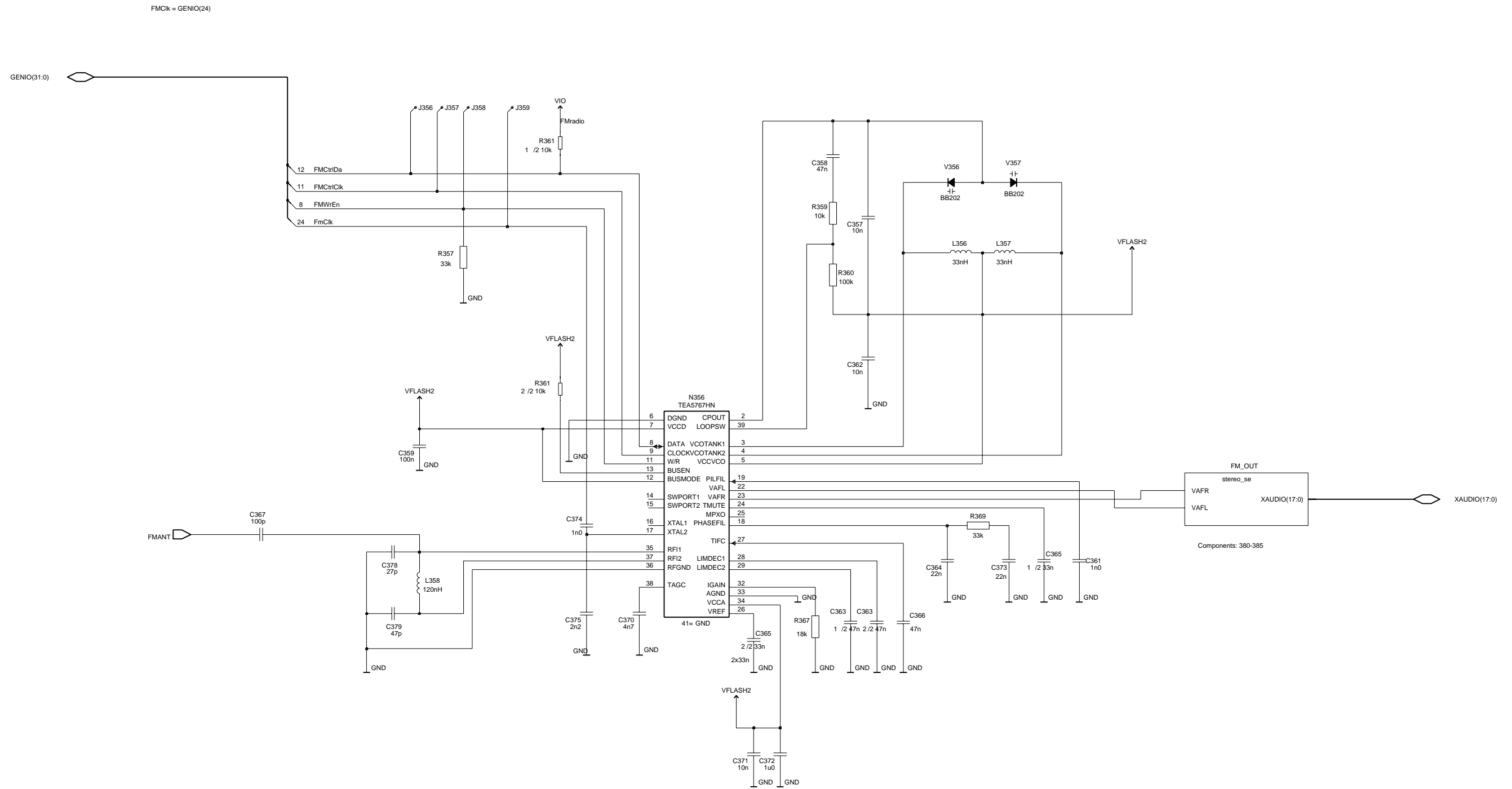

Notice:
 C374 (1n0) and C375 (2n2) are configured for 32kHz reference clock
 If reference clock is 6.5MHz, use C374 (3p9) and C375 (10p)

FM radio unit

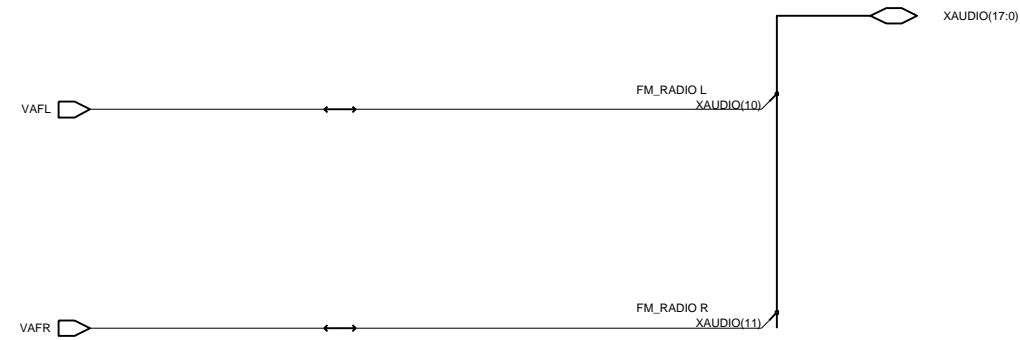

9 pin production test pattern

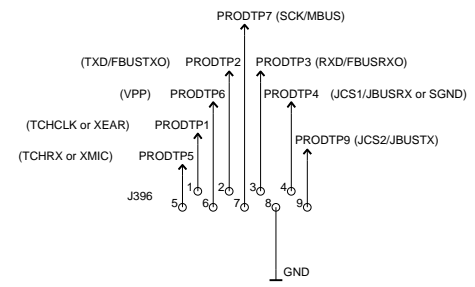

OUT

GSM RF-BB interface

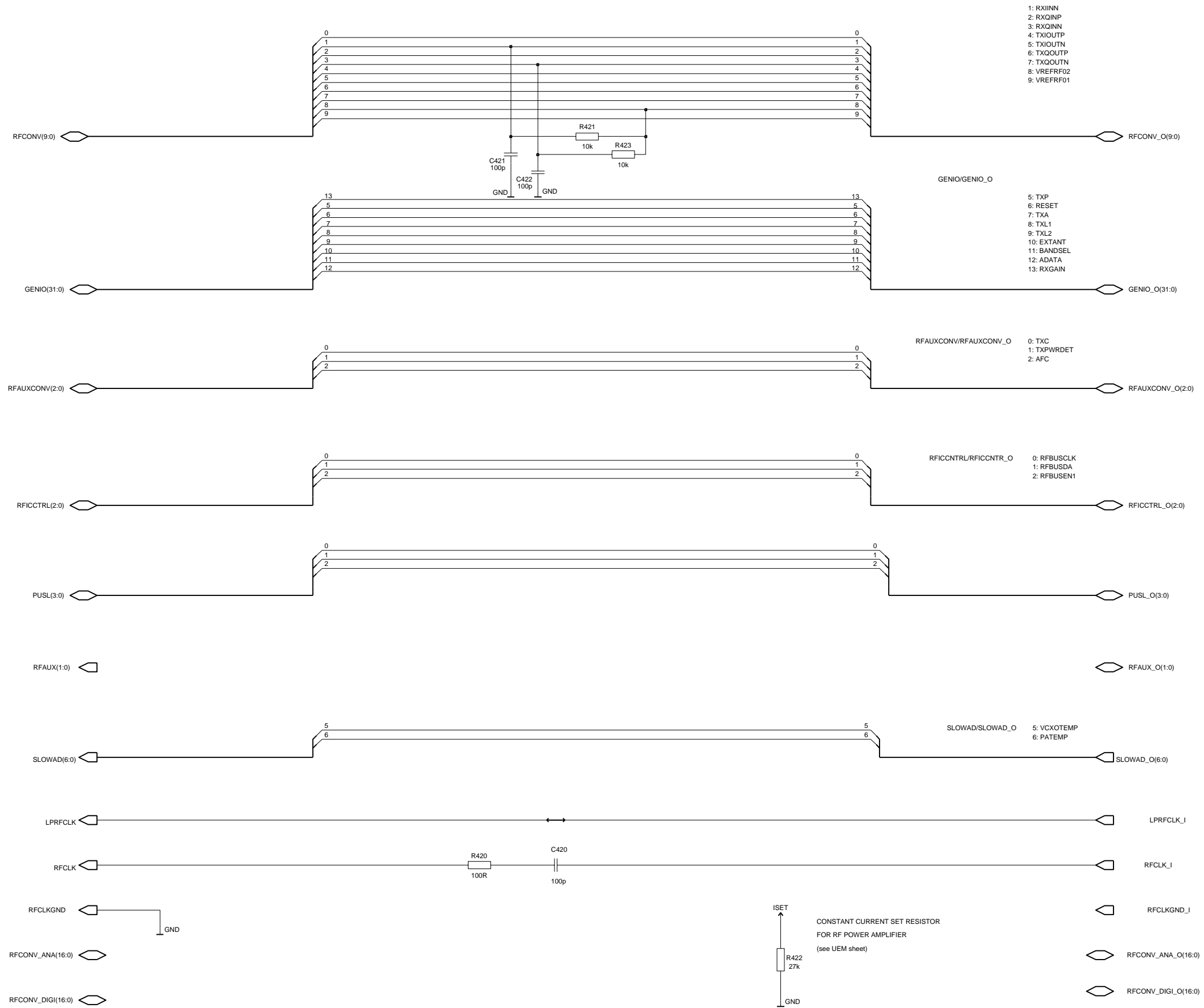

IPA1 AND IPA2 ARE USED IN RF, THE TOLERANCE OF R422 IS 1% (0402, 1430873)

Audio

Varistor arrays have reliability issues

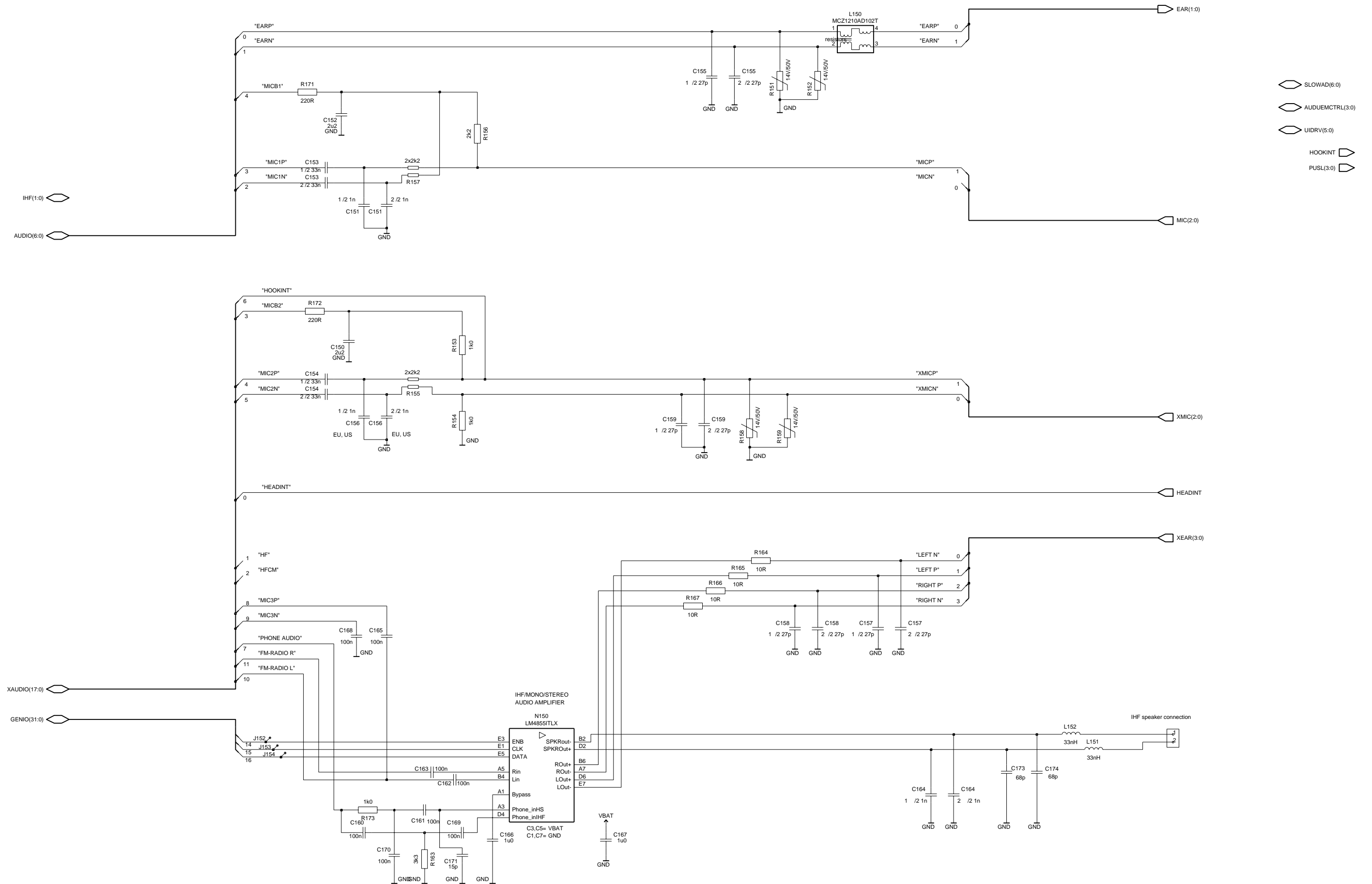

MultiGND symbol bypass

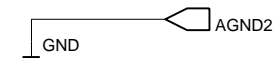
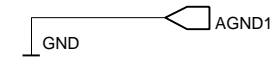
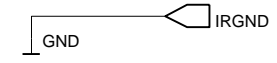

GPS empty sheet

 PUSL(3:0)

 GENIQ(31:0)

Rohm IR module 1.8V

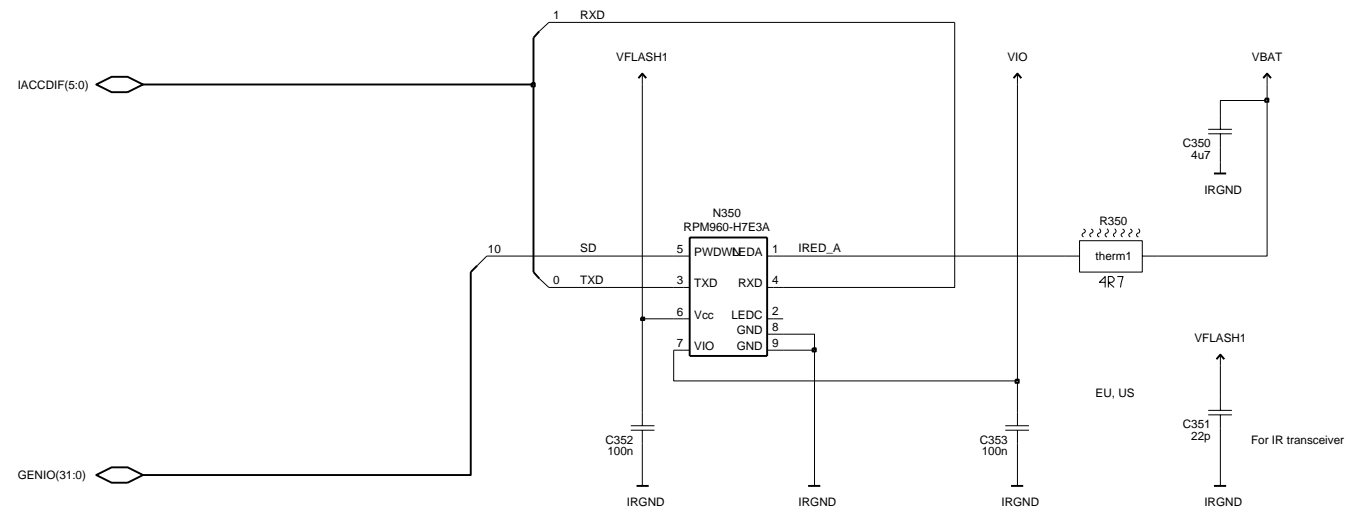

GPIO(31:0)

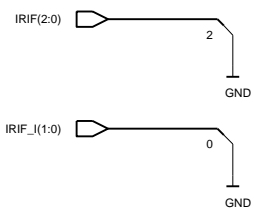

UEM IR level shifters
are ground, when 1.8V
IR is used!

Used referenses

- C 350 - 353
- N 350
- R 350

IR resistor

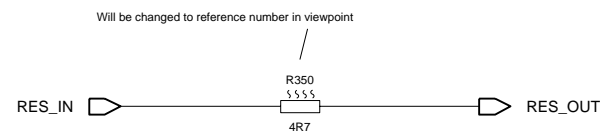

Layout

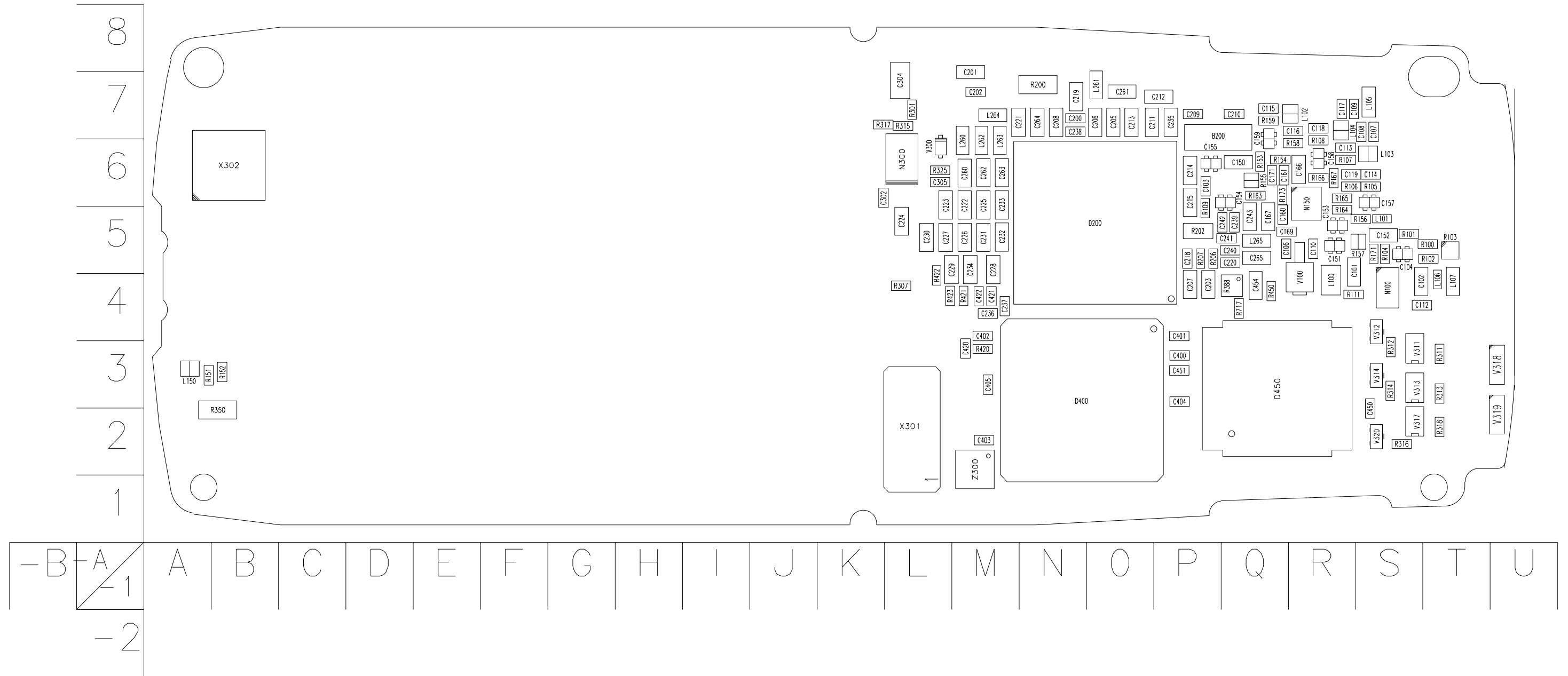

Layout

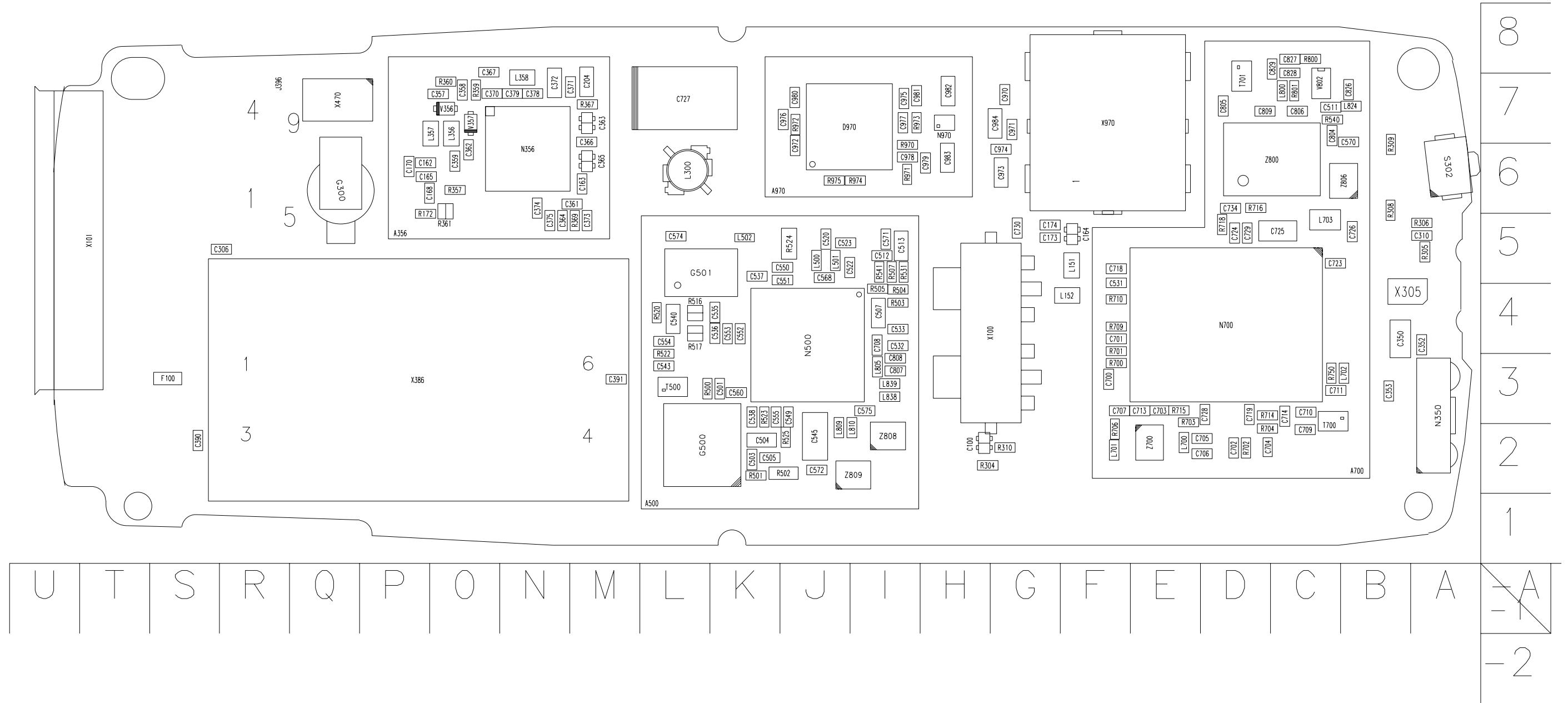

Layout

